

# CLW



## Fluid end Nickel-Plated Brass

### EN

- › Pump body: anodized aluminium alloy
- › Symmetric crankcase featuring top and bottom fixing for easy right to left shaft conversion
- › Head: brass with chemical nickel plating
- › Camshaft: steel
- › Splash lubrication
- › Shaft support bearings oversized for long duration
- › Connecting rods: special anti-friction light alloy
- › Guiding piston: stainless steel
- › Solid ceramic plungers
- › Suction/delivery valves in stainless steel and acetal resin
- › Seals: high dependability
- › Versions in direct drive mount with shaft positionable on the right or left or through shaft.

### ES

- › Cuerpo bomba : en aleación de aluminio anodizado
- › Cáster simétrico dotado de fijaciones superiores e inferiores para saliente eje derecho o izquierdo
- › Culata : en latón con tratamiento de niquelado químico
- › Eje de excéntricas: en acero
- › Lubricación por barboteo
- › Rodamientos de soporte eje de grandes dimensiones para una larga duración
- › Bielas: en aleación ligera especial antifricción
- › Pistones de guía: en acero inoxidable
- › Pistones sumergidos: completamente en cerámica
- › Válvulas de aspiración/impulsión en acero inoxidable y resina acetálica
- › Juntas: de gran fiabilidad
- › Versiones en toma directa con eje configurable a la izda. o dcha., o cigüeñal pasante.

### DE

- › Pumpengehäuse aus eloxierter Aluminiumlegierung
- › Symmetrisches Gehäuse mit Befestigungen oben und unten für Überstand rechte oder linke Welle
- › Zylinderkopf aus Messing mit chemischer Vernickelung
- › Nockenwelle aus Stahl
- › Schüttelschmierung
- › Großzügig bemessene Wellenstützlager für eine lange Lebensdauer
- › Kolbenstangen aus spezieller reibungsloser Leichtlegierung
- › Führungskolben aus Edelstahl
- › Plungerkolben ganz aus Keramik
- › Ansaug- und Auslassventile aus Edelstahl und Azetalharz
- › Sehr zuverlässige Dichtungen
- › Ausführungen mit Direktantrieb, mit Welle rechts oder links konfigurierbar, oder durchgehende Welle.

### IT

- › Corpo pompa in lega d'alluminio anodizzato
- › Carter simmetrico dotato di fissaggi sopra e sotto per sporgenza albero destra o sinistra
- › Testata in ottone con trattamento di nichelatura chimica
- › Albero ad eccentrici in acciaio
- › Lubrificazione a sbattimento
- › Cuscinetti di supporto albero ampiamente sovradimensionati per una lunga durata
- › Bielle in speciale lega leggera antifrizione
- › Pistone di guida in acciaio inox
- › Pistoni tuffanti in ceramica integrale
- › Valvole aspirazione mandata in acciaio inox e resina acetaleica
- › Guarnizioni ad alta affidabilità
- › Versioni in presa diretta con albero configurabile a sx o dx, o albero passante.

### FR

- › Corps de pompe : en alliage d'aluminium anodisé
- › Carter symétrique équipé de fixations au-dessus et au-dessous pour saillie du vilebrequin à droite ou à gauche
- › Tête : en laiton avec traitement de nickelage chimique.
- › Arbre à cames: en acier
- › Lubrification par barbotage
- › Les paliers guidant le vilebrequin sont largement dimensionnés afin de permettre une durée de service accrue
- › Bielles : en alliage léger spécial anti-frottement
- › Piston de guidage: en acier inox
- › Pistons plongeurs : intégraux en céramique
- › Clapets d'aspiration et refoulement en acier inox et résine acétal
- › Garnitures: haute fiabilité
- › Versions à prise directe avec vilebrequin configurable à gauche ou à droite, ou passant.

Routine maintenance includes easy operations such as: oil check & change, check and possible replacement of seals.

El mantenimiento ordinario incluye operaciones simples, como el control y cambio de aceite, el control y, si es el caso, la sustitución de las juntas.

Die ordentliche Wartung umfasst einfache Vorgänge wie Ölkontrolle und -wechsel, Kontrolle und eventuelles Ersetzen der Dichtungen.

La manutenzione ordinaria comprende semplici operazioni quali, controllo e cambio olio, controllo ed eventuale sostituzione guarnizioni.

L'entretien courant comprend de simples opérations telles que le contrôle et la vidange de l'huile, le contrôle et la substitution éventuelle des garnitures.

Code	Model										
		rpm	l/min	US gpm	bar	psi	MPa	kW	HP	kg	lb
6915 0013	CLW 49/200	1000	49	12,9	200	2900	20	19	26	33	72,75
6915 0014	CLW 66/140	1000	66	17,4	140	2030	14	18,5	25	33	72,75
6915 0015	CLW 70/130	1450	70	18,5	130	1885	13	17,5	24	33	72,75
6915 0012	CLW 80/100	1150	80	21,1	100	1450	10	16	21	33	72,75
6915 0011	CLW 100/100	1450	100	26,5	100	1450	10	19	26	33	72,75

▲ **Double shaft version available on request** / Doble eje version disponible bajo pedido / Lieferbar mit doppelwelle Ausführung auf Anfrage / Disponibile in versione albero bisporgente su richiesta / Double arbre sortie disponible à la demande.

■ **Flushing systems available on request** / Versiones disponibles bajo pedido con sistema de enjuague juntas estancas. / Versionen auf Anfrage mit Spülsystem der Dichtungen erhältlich / Versioni disponibili su richiesta con sistema di flussaggio tenute. / Versions disponibles à la demande avec système de fluxage des joints d'étanchéité.

\* **PULSE system on request (only with brass head)** / Sistema PULSE bajo pedido (solo con cabezal de latón) / PULSE-System auf Anfrage (nur mit Messingkopf) / Sistema PULSE su richiesta (solo con testata in ottone) / Système PULSE à la demande (uniquement avec tête en laiton).

● **Max Inlet Pressure** / Presión Máx entrada / Höchstdruck am Eingang / Pressione Max Ingresso / Pression Max. entrée: 3 bar - 43,5 p.s.i.  
**Oil Capacity** / Capacidad aceite / Ölinhalt / Capacità Olio / Capacité huile: 2.51 l ⚡15W 40

## CLW CONNECTION KIT › KIT CONEXIONES › ANSCHLUSS KIT › KIT CONNESSIONI › KIT DE CONNEXIONS

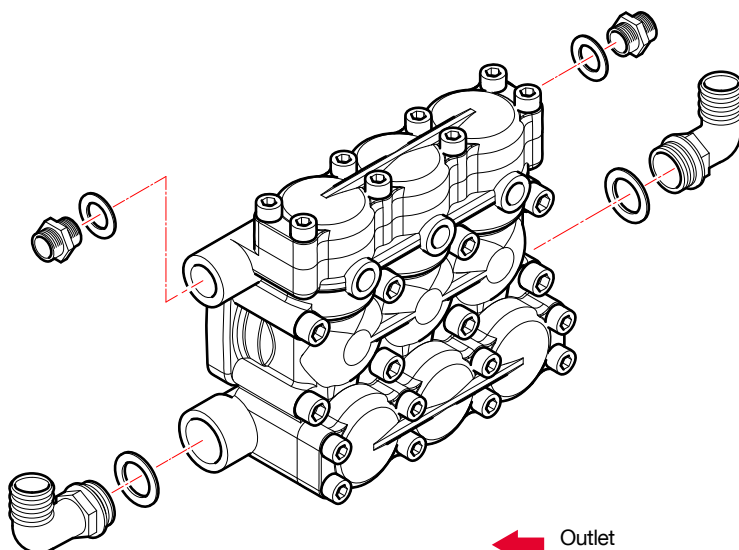

**Available in hot-water version max 85°C**

Disponibile in versione para agua caliente máx. 85°C

Erhältlich in der Ausführung für max. 85° C warmes Wasser

Disponibile in versione per acqua calda max 85°C

Disponibile en version pour eau chaude max. 85°C

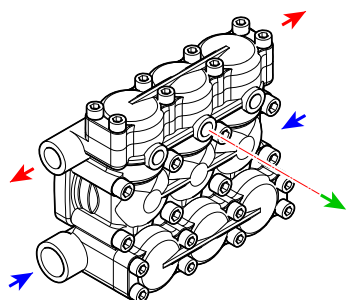

← Outlet  
Impulsión  
Förderleistung  
Mandata  
Refoulement

→ Inlet  
Aspiración  
Ansaugung  
Aspirazione  
Aspiration

↑ Pressure gauges  
Manómetros  
Manometer  
Manometri  
Manomètres

←		2803 0588	3/4" G
		2803 0595	3/4"-1/2" G
		3200 0171	3/4" G
→		2803 0590	1" G - Ø 30
		2803 0701	1" G - Ø 30
		2803 0702	1" G
↑		3202 0387	1" G
		3200 0172	3/8" G
		2803 0697	3/8" G
		2803 0698	3/8"-1/4" G

**CLW** TECHNICAL FEATURES > CARACTERÍSTICAS TÉCNICAS > TECHNISCHE DATEN > CARATTERISTICHE TECNICHE > CARACTERISTIQUES TECHNIQUES

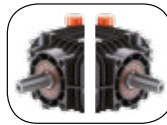
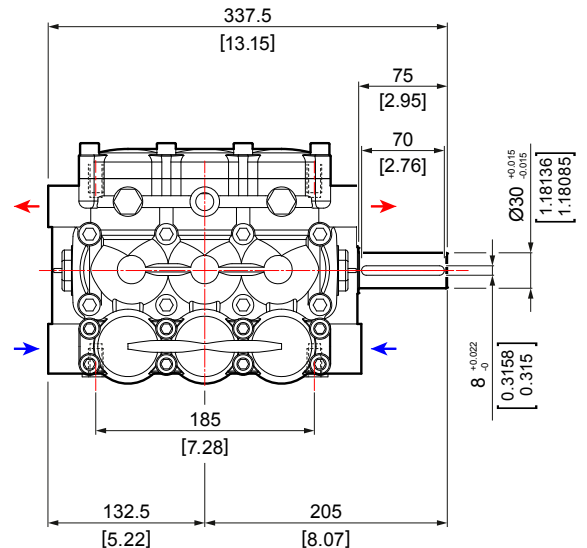
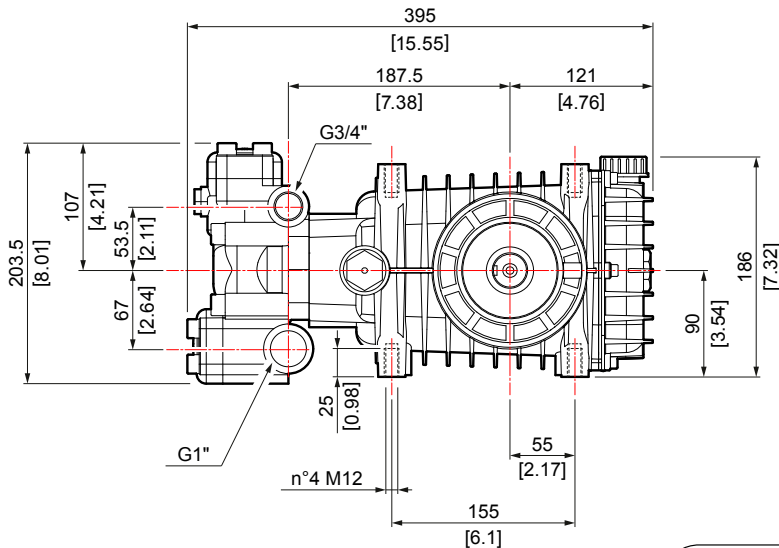

**SYMMETRICAL - REVERSIBLE CARTER / CÁRTER**  
 SIMÉTRICO - REVERSIBLE / SYMMETRISCHES GEHÄUSE -  
 REVERSIBEL / CARTER SIMMETRICO - REVERSIBILE /  
 CARTER SYMÉTRIQUE - RÉVERSIBLE.

**CLW** FLANGE FOR DIRECT DRIVE MOUNT (OPTION) > BRIDA SOPORTE PARA ACCIONAMIENTOS DIRECTOS (OPCIONAL) > TRÄGERFLANSCH FÜR DIREKTE ANTRIEBE (SONDERZUBEHÖR) > FLANGIA SUPPORTO PER AZIONAMENTI DIRETTI (OPZIONALE) > BRIDE DE SUPPORT POUR ACTIONNEMENTS DIRECTS (OPTION)

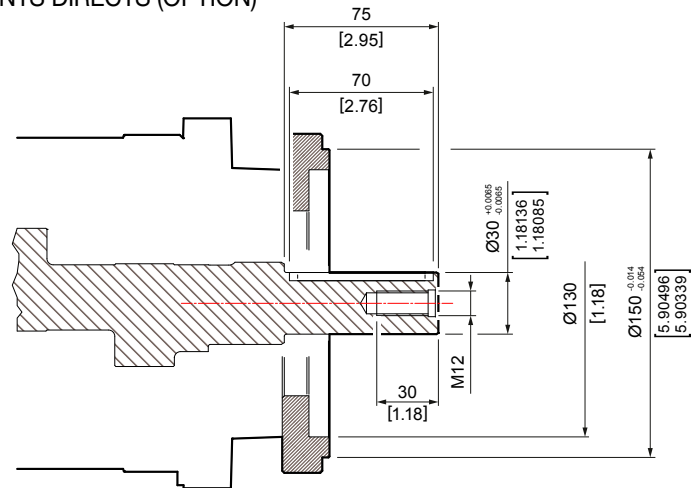
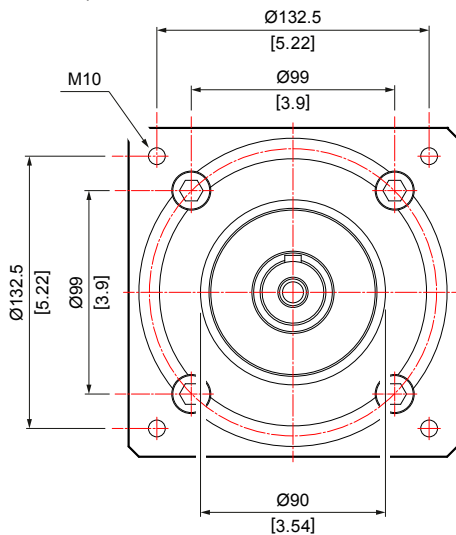

**Kit Code:**  
**5011 0300**  
**FLANGE**  
 BRIDA  
 FLANSCH  
 FLANGIA  
 BRIDE

**CLW** BELL HOUSING AND COUPLING FOR HYDRAULIC MOTOR (OPTION) > KIT CAMPANA Y JUNTA PARA ACOPLAMIENTO A MOTORES HIDRÁULICOS (OPCIONAL) > GLOCKEN- UND VERBINDUNGSSET FÜR KOPPLUNG MIT HYDRAULIKMOTOREN (SONDERZUBEHÖR) > KIT CAMPANA E GIUNTO PER ACCOPPIAMENTO A MOTORI IDRAULICI (OPZIONALE) > KIT CLOCHE ET JOINT POUR ACCOUPLEMENT À DES MOTEURS HYDRAULIQUES (OPTION)

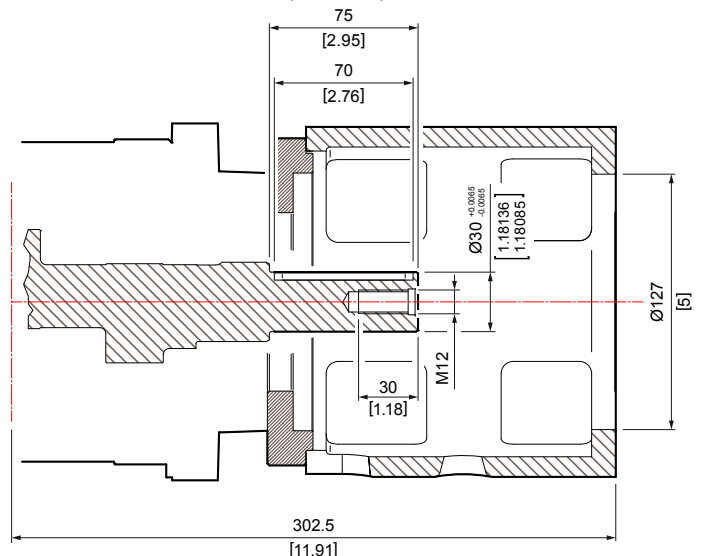
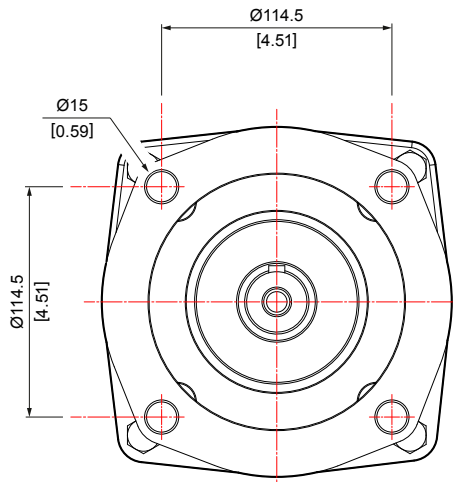

**Kit Code:**  
**5011 0276**  
**BELL**  
 CAMPANA  
 GLOCKE  
 CAMPANA  
 CLOCHE  
**ON REQUEST**  
**COUPLING**  
 JUNTA  
 KOPPLUNG  
 GIUNTO  
 JOINT

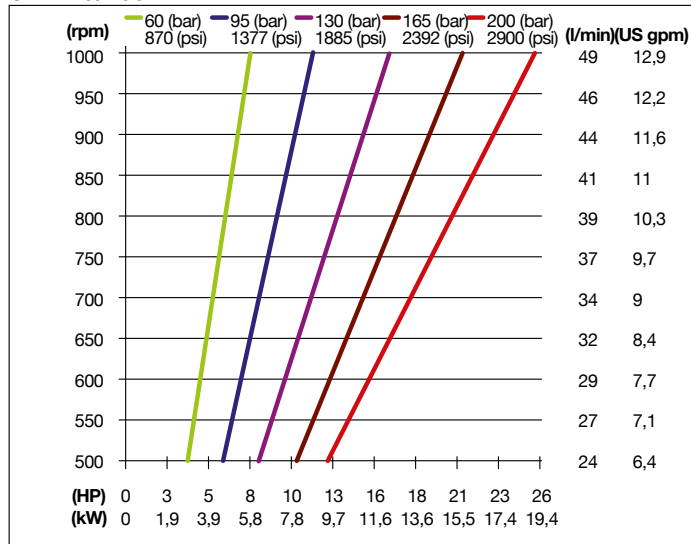
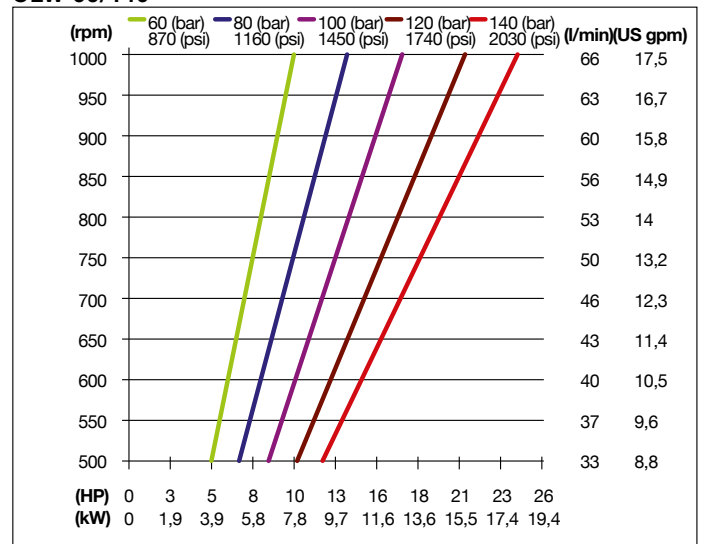
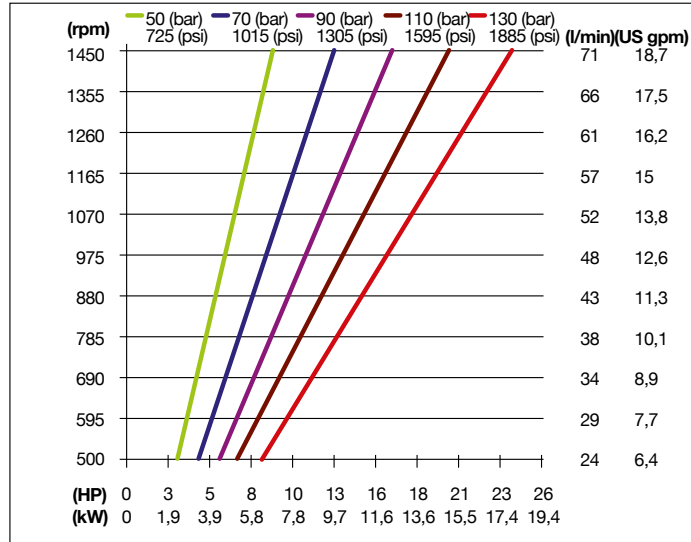
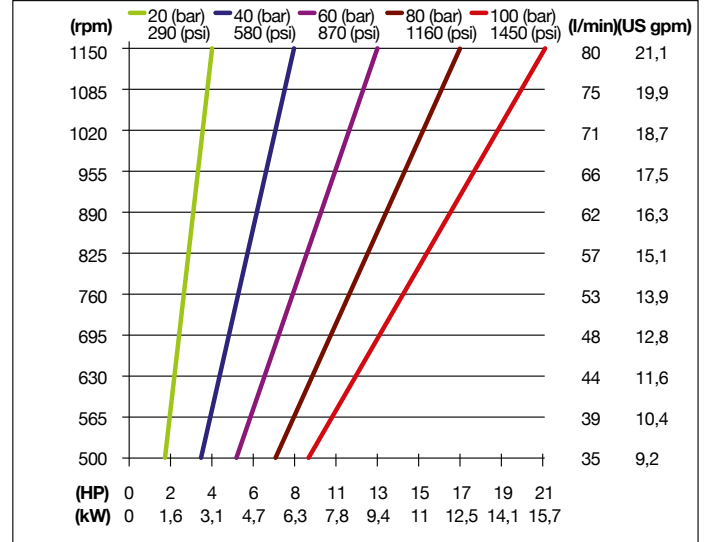
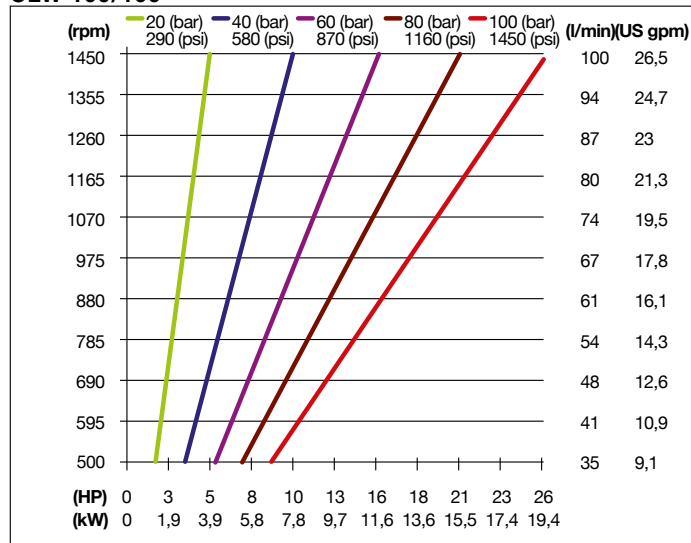
**CLW CHARACTERISTIC CHART › DIAGRAMA DE PRESTACIONES › LEISTUNGSDIAGRAMME ›  
 DIAGRAMMI PRESTAZIONALI › DIAGRAMME DES PERFORMANCES**
**CLW 49/200**

**CLW 66/140**

**CLW 70/130**

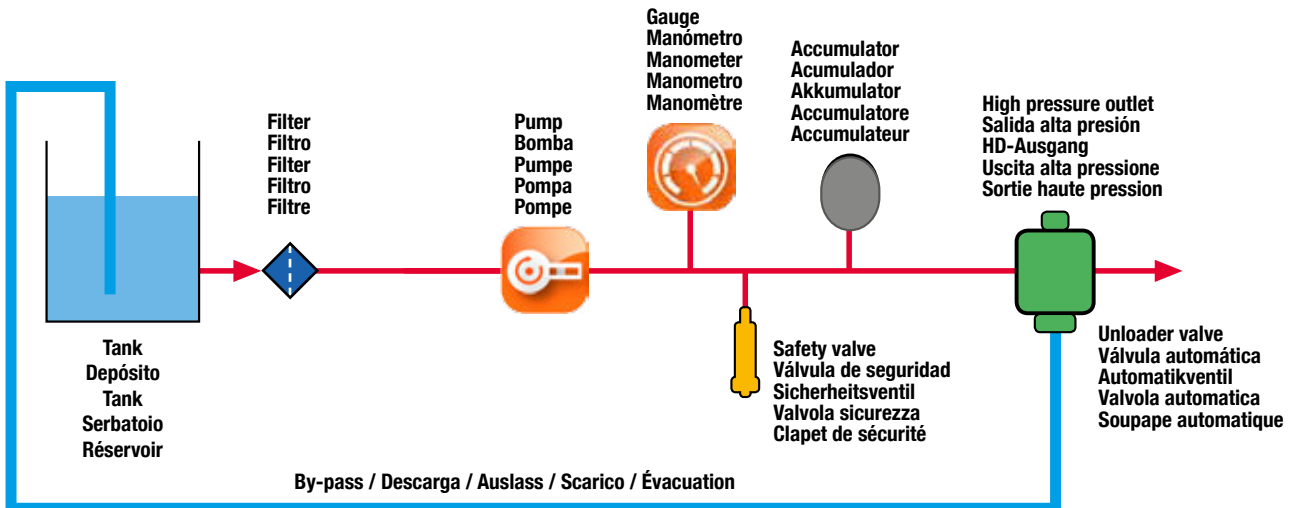
**CLW 80/100**

**CLW 100/100**

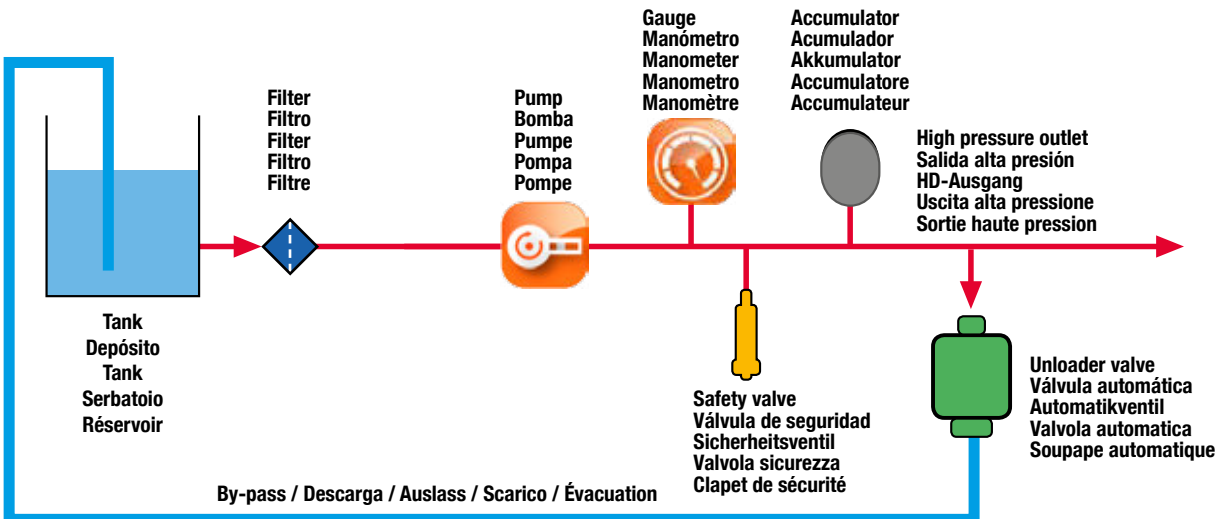
- › Performances refer to theoretical delivery with 100% volumetric efficiency. For continuous or heavy-duty use, contact our technical department
- › Las prestaciones se refieren al caudal teórico con rendimiento volumétrico del 100%. Para usos de servicio continuo o gravoso, contactar con nuestra oficina técnica.
- › Die Leistungen beziehen sich auf eine theoretische Förderleistung mit volumetrischem Wirkungsgrad von 100%. Für eine Dauerverwendung oder eine unter schweren Bedingungen unsere Technikabteilung konsultieren.
- › Le prestazioni sono riferite alla portata teorica con rendimento volumetrico 100%. Per utilizzi di servizio continuo o gravoso, contattare il ns. ufficio tecnico
- › Les performances indiquées se rapportent au débit théorique avec rendement volumétrique 100 %. Pour des conditions d'utilisation dans des applications continues ou difficiles, contactez notre service technique.

# INSTALLATION SCHEME / ESQUEMA DE MONTAJE / MONTAGESCHEMA SCHEMA DI MONTAGGIO / SCHÉMA DE MONTAGE



**INSTALLATION SCHEME With unloader valve / ESQUEMA DE MONTAJE con válvula automática**  
**MONTAGESCHEMA mit Automatikventil / SCHEMA DI MONTAGGIO con valvola automatica**  
**SCHÉMA DE MONTAGE avec soupape automatique**



**INSTALLATION SCHEME With pressure regulation valve / ESQUEMA DE MONTAJE con válvula limitadora de presión**  
**MONTAGESCHEMA mit Überdruckventil / SCHEMA DI MONTAGGIO con valvola di massima pressione**  
**SCHÉMA DE MONTAGE avec limiteur de pression**

## p > 800 bar

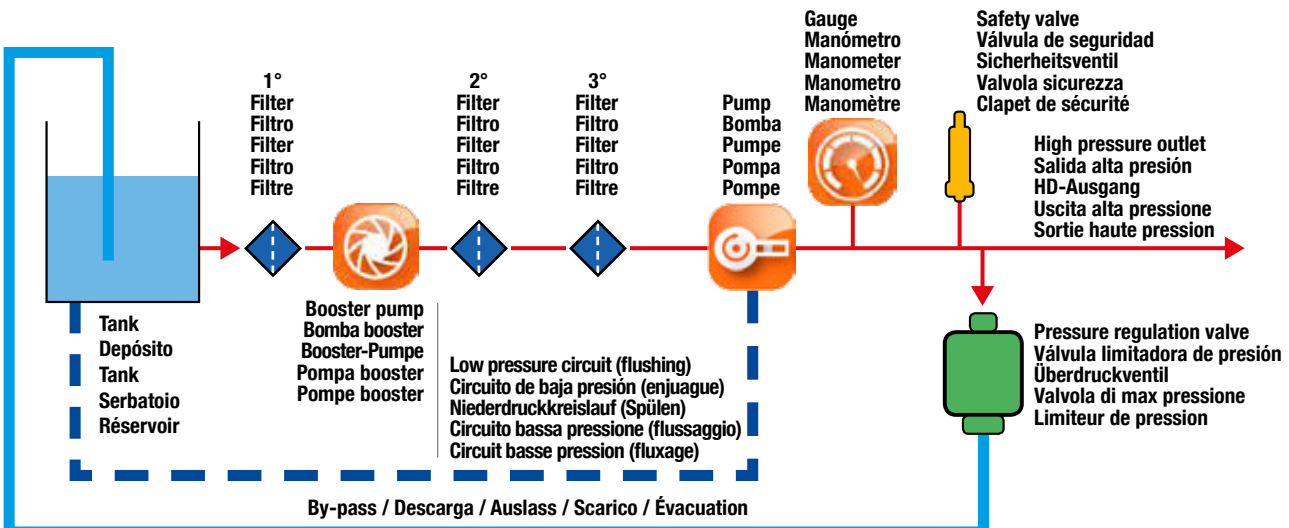

# Accessories

# Accesorios

# Zubehör





# Accessori

# Accessoires













**UNLOADER VALVES › VÁLVULAS AUTOMÁTICAS › DRUKREGLERAUTOMATIK › VALVOLE AUTOMATICHE  
VANNES AUTOMATIQUES**
**BP 01/A**

CODE										Materiale	Su pompa
	l/min	US gpm	bar	psi	g	oz	in	out	by-pass		
1215 0587	100	26,4	170	2465	1160	40,92	G1/2F	G1/2F	G1/2F	Nickel plated brass / Latón niquelado / Vernickelter Messing / Ottone nichelato / Laiton nickelé	CL - CLW ELR - EL - ELS
1215 0568	100	26,4	320	4640	1175	41,45	G1/2F	G1/2F	G1/2F	Brass / Latón / Messing / Ottone / Laiton	





**BPL 01**

CODE										Materiale	Su pompa
	l/min	US gpm	bar	psi	g	oz	in	out	by-pass		
1215 0512	200	53	150	2175	3400	120	G1" NPT	G1" NPT	G1" NPT	Brass / Latón / Messing / Ottone / Laiton	EL - ELR - ELS EF - EFR - ES - ESR





**BP 250/150 - BP 250/280**

CODE										Materiale	Su pompa
	l/min	US gpm	bar	psi	g	oz	in	out	by-pass		
1215 0627	250	66	150	2175	3200	112,88	G1"F	G1"F	G1"F	Brass / Latón / Messing / Ottone / Laiton	EL - ELR - ELS EF - EFR - ES - ESR GL - GLR SL - SLR
1215 0628	250	66	280	4060	3240	114,29	G1"F	G1"F	G1"F		

**BP 05 - BP 06**

CODE										Materiale	Su pompa
	l/min	US gpm	bar	psi	g	oz	in	out	by-pass		
1215 0487	450	119	200	2900	5950	212,51	G 1"1/4 F	G 1"1/4 F	G 1"1/4 F	Brass / Latón / Messing / Ottone / Laiton	GL - GLR SL - SLR MLR - RLR
1215 0488	450	119	300	4350	6025	215,2	G 1"1/4 F	G 1"1/4 F	G 1"1/4 F		

**BP 80/400 - BP 80/640**

CODE										Materiale	Su pompa
	l/min	US gpm	bar	psi	g	oz	in	out	by-pass		
1215 0611	80	21	400	5800	2090	73,72	G1/2F	G1/2F	G1/2F	Stainless steel / Acero Inoxidable / Edelstahl / Acciaio inox / Acier inox	CH - ELH - ELHR EFH - ESH - ESHR
1215 0612	80	21	640	9200	2090	73,72	G1/2F	G1/2F	G1/2F		

UNLOADER VALVES › VÁLVULAS AUTOMÁTICAS › DRUKREGLERAUTOMATIK › VALVOLE AUTOMATICHE  
VANNES AUTOMATIQUES



### BP 60/400 ZERO - BP 60/600 ZERO

CODE										Materiale	Su pompa
	l/min	US gpm	bar	psi	g	oz	in	out	by-pass		
1215 0531	60	16	400	5800	2125	74,96	G1/2F	G1/2F	G1/2F	Stainless steel / Acero Inoxidable / Edelstahl / Acciaio inox / Acier inox	CH - ELH - ELHR EFH - ESH - ESHR
1215 0532	60	16	600	8700	2130	75,13	G1/2F	G1/2F	G1/2F		



### BP 100/550 - BP 100/550\*

CODE										Materiale	Su pompa
	l/min	US gpm	bar	psi	g	oz	in	out	by-pass		
1215 0632	100	26,4	550	8000	1150	40,57	G1/2F	G1/2F	G1/2F	Stainless steel / Acero Inoxidable / Edelstahl / Acciaio inox / Acier inox	CH - ELH - ELHR EFH - ESH - ESHR
1215 0613 *	100	26,4	550	8000	1150	40,57	G1/2F	G1/2F	G1/2F		



PRESSURE REGULATING VALVES › PRESSURE REGULATING VALVES › PRESSURE REGULATING VALVES › PRESSURE REGULATING VALVES › PRESSURE REGULATING VALVES



### RP 01/A

CODE										Materiale	Su pompa
	l/min	US gpm	bar	psi	g	oz	in	out	by-pass		
1215 0572	100	26,4	320	4640	1175	41,45	G1/2"F	G1/2"F	G1/2"F	Brass / Latón / Messing / Ottone / Laiton	CL - CLW - ELR EL - ELS

### RP 250/150 - RP 250/280



CODE										Materiale	Su pompa
	l/min	US gpm	bar	psi	g	oz	in	out	by-pass		
1215 0630	250	66	150	2175	3200	112,88	G1"F	G1"F	G1"F	Brass / Latón / Messing / Ottone / Laiton	EL - ELR - ELS EF - EFR - ES - ESR GL - GLR SL - SLR
1215 0631	250	66	280	4060	3240	114,29	G1"F	G1"F	G1"F		

### RP 04/A



CODE									Materiale	Su pompa
	l/min	US gpm	bar	psi	g	oz	in	by-pass		
1215 0624	480	127	280	4060	8900	314	G 1"1/4 F	G 1"1/4 F	Stainless steel / Acero Inoxidable / Edelstahl / Acciaio inox / Acier inox	SL - SLR MLR - RLR

### RP 80/640



CODE										Materiale	Su pompa
	l/min	US gpm	bar	psi	g	oz	in	out	by-pass		
1215 0616	80	21	640	9200	2150	75,8	G1/2"F	G1/2"F	G1/2"F	Stainless steel / Acero Inoxidable / Edelstahl / Acciaio inox / Acier inox	CH - ELH - ELHR EFH - SLH





### RP 100/550







CODE										Materiale	Su pompa
	l/min	US gpm	bar	psi	g	oz	in	out	by-pass		
1215 0615	100	26,4	550	8000	1100	38,8	G1/2"F	G1/2"F	G1/2"F	Stainless steel / Acero Inoxidable / Edelstahl / Acciaio inox / Acier inox	CH - ELH - ELHR EFH - ESH - ESHR

PRESSURE REGULATING VALVES › PRESSURE REGULATING VALVES › PRESSURE REGULATING VALVES ›  
 PRESSURE REGULATING VALVES › PRESSURE REGULATING VALVES

**RP 06**

CODE									Materiale	Su pompa
	l/min	US gpm	bar	psi	g	oz	in	by-pass		
1215 0509	60	16	1000	14500	1570	55,38	G1/2"M	G3/8"F	Stainless steel / Acero Inoxidable / Edelstahl / Acciaio inox / Acier inox	EV EFV - EFVR ESV - ESVR

**RP 09**

CODE									Materiale	Su pompa
	l/min	US gpm	bar	psi	g	oz	in	by-pass		
1215 0648	40	10,6	2800	40610	2200	77,6	M26x1,5 M	3/4" BSP F	Stainless steel / Acero Inoxidable / Edelstahl / Acciaio inox / Acier inox	EV EFV - EFVR ESV - ESVR

**PRESSURE REGULATING VALVES (COMPRESSED AIR CONTROL)** › PRESSURE REGULATING VALVES (COMPRESSED AIR CONTROL) › PRESSURE REGULATING VALVES (COMPRESSED AIR CONTROL) › PRESSURE REGULATING VALVES (COMPRESSED AIR CONTROL) › PRESSURE REGULATING VALVES (COMPRESSED AIR CONTROL)



### RP PN 02

CODE										Materiale	Su pompa
	l/min	US gpm	bar	psi	g	oz	in	out	by-pass		
1215 0492	200	53	150	2175	2025	71,4	G1" F	G1" F	G1" F	Brass / Latón / Messing / Ottone / Laiton	CL - CLW ELR - ELS - EF

### RP PN 03/2 - RP PN 03/3



CODE										Materiale	Su pompa
	l/min	US gpm	bar	psi	g	oz	in	out	by-pass		
1215 0497	200	53	200	2900	1500	52,9	G1" F	G1" F	G1" F	Cast iron / Hierro fundido / Gusseisen / Ghisa / Fonte	CL - CLW ELR - ELS - EF
1215 0500	200	53	100	1450	1500	52,9	G1" F	G1" F	G1" F		

### RP PN 06



CODE										Materiale	Su pompa
	l/min	US gpm	bar	psi	g	oz	in	out	by-pass		
1215 0590	200	53	280	4060	4515	159,26	G1" F	G1" F	G1" F	Brass / Latón / Messing / Ottone / Laiton	EF - ES - GL - GLR SL - SLR

### RP PN 05 - RP PN 05/2



CODE										Materiale	Su pompa
	l/min	US gpm	bar	psi	g	oz	in	out	by-pass		
1215 0514	320	84,5	300	4350	2800	98,7	G 1"1/2 F	G 1"1/2 F	G 1"1/2 F	Cast iron / Hierro fundido / Gusseisen / Ghisa / Fonte	ES - GL - GLR - SL SLR - MLR - RLR
1215 0502	480	127	170	2465	2800	98,7	G 1"1/2 F	G 1"1/2 F	G 1"1/2 F		

### RP PN 07



CODE										Materiale	Su pompa
	l/min	US gpm	bar	psi	g	oz	in	out	by-pass		
1215 0634	80	21	560	8120	3540	124,86	G1/2" F	G1/2" F	G1/2" F	Stainless steel-brass / Acero inoxidable-latón / Edelstahl-Messing / Acciaio inossidabile / Ottone / Acier inox-laiton	ELH - ELHR EFH - EFHR ESH - ESHR

### RP PN 03



CODE										Materiale	Su pompa
	l/min	US gpm	bar	psi	g	oz	in	out	by-pass		
1215 0493	200	53	500	7250	1800	63,5	G1" F	G1" F	G1" F	Cast iron / Hierro fundido / Gusseisen / Ghisa / Fonte	CH - ELH - ELHR EFH - ESH

**VS 100/250 - VS 100/500**

CODE									Materiale	Su pompa
	l/min	US gpm	bar	psi	g	oz	in	by-pass		
1219 2072	100	26,4	100 ÷ 250	1450 ÷ 3630	1260	44,45	G1/2" F	G1/2" F	Brass / Latón / Messing / Ottone / Laiton	CLW - CL EL - ELR - ELS
1219 2064	100	26,4	200 ÷ 500	2900 ÷ 7250	1480	52,21	G1/2" F	G1/2" F		CH - ELH - ELHR EFH - ESH

**VS 250/180**

CODE									Materiale	Su pompa
	l/min	US gpm	bar	psi	g	oz	in	by-pass		
1219 2066	250	67	18 ÷ 180	260 ÷ 2600	1140	40,1	G3/4" F	G3/4" F	Brass / Latón / Messing / Ottone / Laiton	EF - ES - GL - GLR SL - SLR

**VS 07/A - VS 08/A**

CODE									Materiale	Su pompa
	l/min	US gpm	bar	psi	g	oz	in	by-pass		
1219 2061	450	120	150 ÷ 300	2175 ÷ 4350	4800	169	G1" F	G1" F	Brass / Latón / Messing / Ottone / Laiton	MLR - RLR - GLR SLR - ESR
1219 2060	450	120	100 ÷ 200	1450 ÷ 2900	4650	164	G1" F	G1" F		



**VS 60/400 - VS 60/660**

CODE									Materiale	Su pompa
	l/min	US gpm	bar	psi	g	oz	in	by-pass		
1219 2063	60	16	280 ÷ 400	4000 ÷ 5800	2000	70,55	Rc 3/8" F	G1/2" F	Stainless steel / Acero Inoxidable / Edelstahl / Acciaio inox / Acier inox	EFH - EFHR ESH - ESHR ELH - ELHR CH
1219 2059	60	16	500 ÷ 660	7250 ÷ 9570	2000	70,55	Rc 3/8" F	G1/2" F		



**VS 06**

CODE									Materiale	Su pompa
	l/min	US gpm	bar	psi	g	oz	in			
1219 2046	30	7,8	750	10800	200	7,05	G1/2" M	Stainless steel / Acero Inoxidable / Edelstahl / Acciaio inox / Acier inox	EV - EFV ESV - ESVR	
1219 2047	30	7,8	1000	14500	200	7,05	G1/2" M			
1219 2048	30	7,8	1250	18000	200	7,05	G1/2" M			
1219 2069	30	7,8	1500	21750	200	7,05	G1/2" M			
1219 2070	30	7,8	1750	25375	200	7,05	G1/2" M			

**MA 01 - 02 - 03 - 04 - 05**





CODE					Ø DN63 connection	Accuracy class Classe di precisione
	bar	psi	g	oz		
1816 0140	0-250	0-3625	210	7,40	G1/4" B	1,6
1816 0141	0-315	0-4570	210	7,40	G1/4" B	1,6
1816 0142	0-400	0-5800	210	7,40	G1/4" B	1,6
1816 0143	0-600	0-8700	210	7,40	G1/4" B	1,6
1816 0144	0-1000	0-14500	210	7,40	G1/4" B	1,6

**MA 06 - 07 - 08 - 09 - 10**





CODE					Ø DN100 connection	Accuracy class Classe di precisione
	bar	psi	g	oz		
1816 0145	0-600	0-8700	800	28,21	G1/2" B	1,0
1816 0146	0-1000	0-14500	800	28,21	G1/2" B	1,0
1816 0147	0-1600	0-23200	800	28,21	G1/2" B	1,0
1816 0161	0-2500	0-36250	800	28,21	G1/2" B	1,0
1816 0162	0-4000	0-58000	1100	38,80	M16x1,5 F	1,0

FOOT VALVE › PRESSURE REGULATING VALVES (COMPRESSED AIR CONTROL) › PRESSURE REGULATING VALVES (COMPRESSED AIR CONTROL) › PRESSURE REGULATING VALVES (COMPRESSED AIR CONTROL) › PRESSURE REGULATING VALVES (COMPRESSED AIR CONTROL)

**VP 80/500**

CODE								
	l/min	US gpm	bar	psi	g	oz	in	out
0608 0106	80	21	500	7250	7593	267,83	G1/2" F	G1/2" F

**VP 01**

CODE								
	l/min	US gpm	bar	psi	g	oz	in	out
0608 0056	60	16	1050	15000	5090	179,54	G1/2" M	G1/2" M

**FILTERS › FILTROS › FILTER › FILTRI › FILTRES**

**FP 01**
**FP 02**
**FP 05**
**FP 06**
**FA 01**
**FA 02**
**FA 03**

CODE								Materiale
		l/min	US gpm	bar	psi	in / out		
1002 0201	FP 01	70	18,5	12	174	1" G	Plastic / Plástico / Plastik / Plastica / Plastique	
1002 0202	FP 02	110	29	12	174	1" 1/4 G	Plastic / Plástico / Plastik / Plastica / Plastique	
1002 0208	FP 05	200	52,8	8	116	2" G	Plastic / Plástico / Plastik / Plastica / Plastique	
1002 0209	FP 06	400	105,6	8	116	3" G	Plastic / Plástico / Plastik / Plastica / Plastique	
1002 0205	FA 01	150	39,6	30	435	1" 1/2 G	Aluminium / Aluminio / Aluminium / Alluminio / Aluminium	
1002 0206	FA 02	260	68,7	10	145	3" G	Aluminium / Aluminio / Aluminium / Alluminio / Aluminium	
1002 0254	FA 03	30	7,9	10	145	1" G	Steel body 100 micron cartridge / Cuerpo acero cartucho 100 micras / Gehäuse Stahl Einsatz 100 Micron / Corpo acciaio cartuccia 100 micron / Corps acier cartouche 100 micron	
1002 0255	FA 03	30	7,9	10	145	1" G	Steel body polypropylene 25 micron cartridge / Cuerpo acero cartucho 25 micras polipropileno / Gehäuse Stahl Einsatz 25 Micron Polypropylen / Corpo acciaio cartuccia 25 micron polipropilene / Corps acier cartouche 25 micron polypropylène	

**PULSATION DAMPENERS › ACUMULADORES ANTIPULSACIONES › DRUCKSPEICHER › ACCUMULATORI ANTIPULSAZIONI › BALLONS ANTI BÉLIER**





**AP 01**
**AP 02**
**AP 03**
**AP 04**
**AP 05**
**AP 06**

CODE								in	Materiale
		Capacity / Volume (lt)	bar	psi	g	oz			
0102 0034	AP 01	0,35	210	3045	1700	60	M18x1,5 F	Press. Steel	
0102 0035	AP 02	0,70	210	3045	2700	95,2		Press. Steel	
0102 0036	AP 03	0,80	300	4351	5800	204,6		Forg. Steel	
0102 0037	AP 04	1,00	210	3045	3500	123,4		Press. Steel	
0102 0038	AP 05	1,40	210	3045	4900	172,8		Press. Steel	
0102 0039	AP 06	1,50	300	4351	8700	307		Forg. Steel	

**NON RETURN VALVE › VÁLVULAS ANTI RITORNO › DAS ABSPERRVENTIL › VALVOLE DI NON RITORNO › VALVE DE NON RETOUR**





### VRN 01 - VRN 02



CODE								
	l/min	US gpm	bar	psi	g	oz	in	out
0608 0051	180	48	150	2200	350	12,34	G3/4" F	G3/4" F
0608 0052	180	48	400	5800	370	13,05	G3/4" F	G3/4" F





### VRN 03



CODE								
	l/min	US gpm	bar	psi	g	oz	in	out
0608 0098	80	21	640	9280	509	17,95	G1/2" F	G1/2" F

### VRN 04



CODE								
	l/min	US gpm	bar	psi	g	oz	in	out
0608 0099	450	118	280	4000	2058	72,59	G1/2" F	G1/2" F



GUNS WITH LANCES › PISTOLAS CON LANZAS › PISTOLEN MIT STRAHLOHREN › PISTOLE CON LANCE › PISTOLET AVEC LANCES

**LC 210**

CODE									
	l/min	US gpm	bar	psi	g	oz	in	out	mm
2410 0223	200	53	200	2900	1710	60,31	G3/4" F	1/4" NPTF	420
2410 0213	200	53	200	2900	2245	79,19	G3/4" F	1/4" NPTF	820
2410 0214	200	53	200	2900	2820	99,47	G3/4" F	1/4" NPTF	1220

**LC 510**

CODE									
	l/min	US gpm	bar	psi	g	oz	in	out	mm
2410 0224	60	16	500	7250	1810	63,84	G1/2" F	1/4" NPTF	420
2410 0215	60	16	500	7250	2345	82,71	G1/2" F	1/4" NPTF	820
2410 0216	60	16	500	7250	2920	103	G1/2" F	1/4" NPTF	1220

**LC 710**

CODE									
	l/min	US gpm	bar	psi	g	oz	in	out	mm
2410 0217	60	16	640	9280	2050	72,31	G3/8" F	1/4" NPTF	820
2410 0218	60	16	640	9280	2650	93,47	G3/8" F	1/4" NPTF	1220

**LC 06**

CODE									
	l/min	US gpm	bar	psi	g	oz	in	out	mm
3301 1192	80	21	1000	14500	3550	125,21	1/2" BSP	1/4" NPT-F	1000